

BALANCED HEAD FAIRLEAD FLANGE MOUNTED

MD-748

STANDARD FEATURES



- Designed for Breaking Strength of 2-1/2" (64 mm) EIPS Wire Rope, 663,700 LBS, with 90° Wrap on the Sheave and 360° Rotation of Swivelhead
- Cast Steel Sheave with Hardened Rope Groove for Longer Life
- Sealed Grease Lubricated Tapered Roller Bearings in Sheave and Swivelhead
- Weld Down Mounting Base
- Removable Guide Roller
- Epoxy Primer Coating

OPTIONAL FEATURES

- Customized Design to Suit Your Application
- Tail Sheaves / Tail Rollers
- Stainless Steel or Nylon Sheaves
- Bolt Down Mounting Base
- Load Monitoring System
- Three Coat Marine Paint System
- Third Party Certification

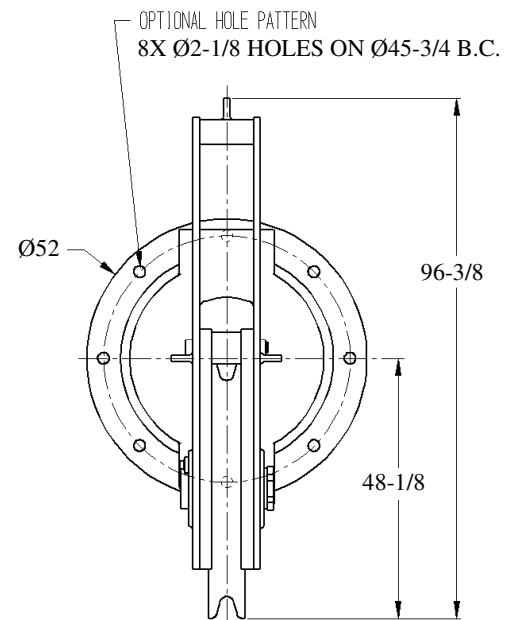
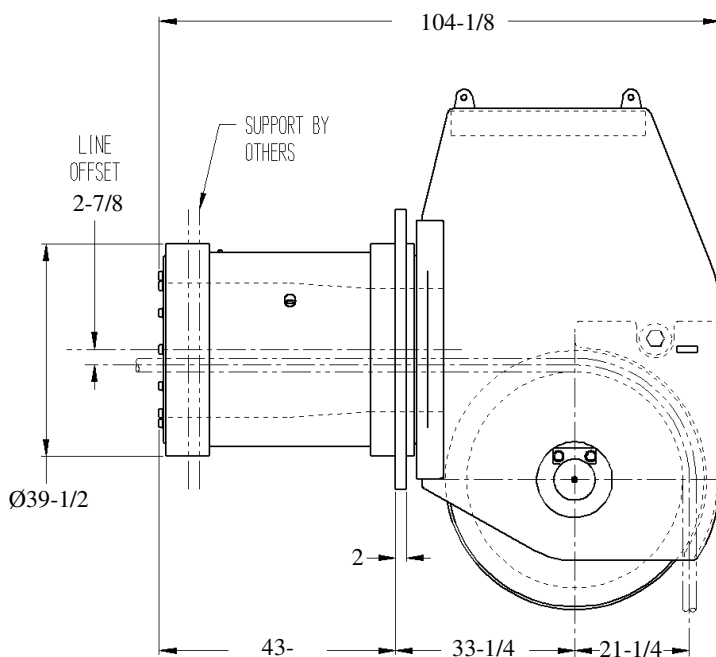

WEIGHT: 12,380 LBS

* DIMENSIONS SUBJECT TO CHANGE WITHOUT NOTICE*

Smith Berger Marine, Inc. - Mooring & Towing Solutions

7915 10th Ave. S., Seattle, WA 98108 USA

Tel. 206.764.4650 - Toll Free 888.726.1688 - Fax 206.764.4653

E-mail: sales@smithberger.com - Web: www.smithberger.com